

Linear

SEN Asymmetric A040 (40W) Fixture Guide

KKDÖ

Exterior | Surface | Output up to 3600lm/m (1097lm/ft)



90lm/W

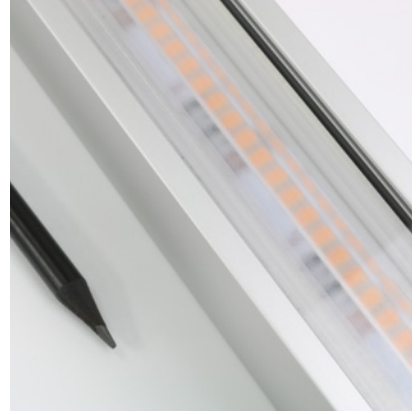

Key applications

- ✓ Architectural detail
- ✓ Building facades
- ✓ Ceiling
- ✓ Direct lighting
- ✓ Downlighting
- ✓ Exterior
- ✓ Public spaces
- ✓ Uplighting
- ✓ Wall grazing
- ✓ Wall mounting
- ✓ Wallwashing
- ✓ Window reveal
- ✓ Wet area

Key features

- ✓ A-line (High Efficacy)
- ✓ Adjustable
- ✓ Asymmetric lens
- ✓ Custom lengths
- ✓ Constant Voltage (CV)
- ✓ Diffusion: homogenous
- ✓ Direct view
- ✓ High lumen efficacy
- ✓ IP44 moisture resistant
- ✓ IP67 waterproof
- ✓ Lens options

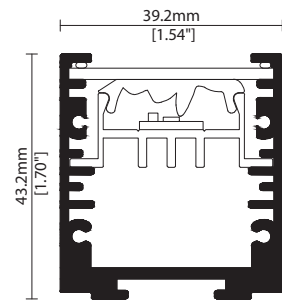

MOUNTING METHODS



KKCP-12 Lock clip



KKBK-02 Fixed bracket



KKBK-09 Mounting plate



KKBK-16 Small adjustable bracket



KKBK-17 Large adjustable bracket



KKBK-23 Low adjustable bracket

Linear

SEN Asymmetric A040 (40W)

Specification sheet



Dimensions	H43.2/W39.2/L97-1020mm (H1.04/W0.98/L3.82-59.84in)
PCB Cut-point	38.46mm increment/1000mm max (1.51in increment/39.37in max)
LED Pitch	4.8mm - 208LED/m (0.19in - 64LED/ft)
Chip	A-line
Cover/Optics	Clear + KKLN-A1 Asymmetric Lens (Beam tilt 25°, Beam angle 50°)
CCT	A-line: 2700K/3000K/4000K
LED binning	A-line: 3-step MacAdam ellipse
CRI	94
Lifetime	50,000 hours @ 25°C (50,000 hours @ 77°F)
Operating temp	T _a = -20 to 50°C (T _c max = 75.6°C) T _a = -13 to 122°F (T _c max = 168°F)
IP Rating	IP44/67
Finish	Silver anodised
Mounting	Surface mounting via brackets
Power feed	Sheathed hardwire tails or male/female connectors
Control	0-10V/1-10V/DMX/DALI



LED Grading Key

Exclusive Grade	*KKDC tuned CCT range
A-line*	3-step CCT range
KKDC highest lumen efficacy LED	

Power consumption	Supply voltage	Supply current
40W/m (12.19W/ft)	24V DC	1.67A/m (0.51A/ft)

Performance Data (3000K)

	R1	R2	R3	R4	R5	R6	R7	R8	R9	R10	R11	R12	R13	R14		
A-line	95	96	95	94	94	94	95	88	72	89	94	77	95	97		
	Clear + KKLN-A1												CRI	R9	Rf	Rg
A-line	3600lm/m (1097lm/ft) 90lm/W												94	72	-	-

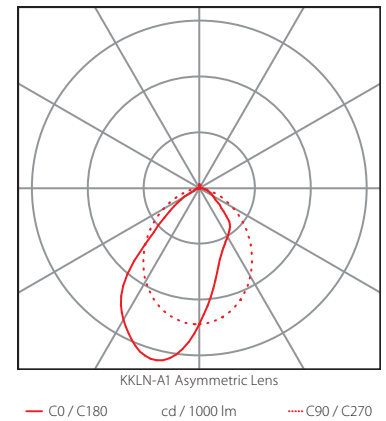
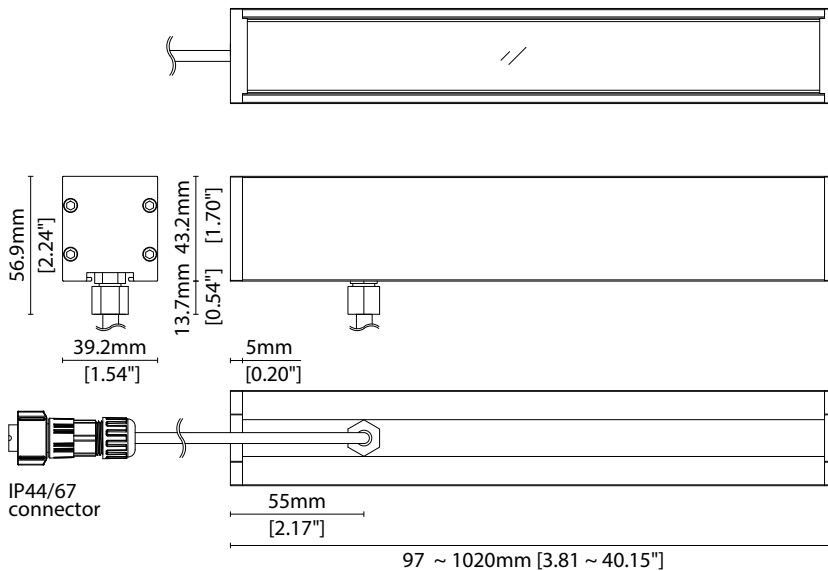

Data derived from independent UKAS/IESNA LM-79-08 accredited testing of production samples.

Linear

SEN Asymmetric A040 (40W) Code Table



FIXTURE

Model	Finish	Cover/ Lens	Grade ¹	LED	Colour (CCT)	Length Availability ²	IP	Cable Length	Power Feed ³	Cable exit	Baffle option	Input		
SEN Asymmetric	SNA Silver Anodised	SA Clear + KKLN-A1 (Asymmetric lens)	BA1	A	A040	2700K 27 m 97-1020mm 38.46mm increments	IP44 44 IP67* 67	300mm (11.81in) 0300	Single ø6.3mm sheath tail S00B	Rear Cable Exit RC	SEN Asymmetric no baffle SXB	DC 24V g		
						3000K 30			Double ø6.3mm sheath tail D00B				Side Cable Exit SC	SEN Asymmetric large baffle (Silver anodised) SLB
						4000K 40 i 3.82-59.84in 1.51in increments (Specify length code OR total run length)			Single ø6.3mm sheath IP67 Male connector S67B				SEN Asymmetric small baffle (Silver anodised) SSB	
								Double ø6.3mm sheath IP67 connector D67B						

¹ Refer to **LED Grading Key** on **Specification sheet** page

² Refer to **Length Availability List** or enter total run length instead of length code

³ Refer to **Power Feed Options** on **Options** pages

⁴ Due to the clear, flush potted polyurethane top layer on IP67 SEN Asymmetric a colour shift of +/- 20K should be expected

Code Example:

SNA	-	SA	-	BA1	-	A	-	A040	-	30	-	m	520	-	67	-	0300	-	D67B	-	RC	-	SLB	-	g
SEN Asymmetric		Silver Anodised		KKLN-A1 (Asymmetric lens)		A		A040		3000K		520mm	IP67		300mm (11.81in)		0300		Double ø6.3mm sheath IP67 connector		Rear cable exit		SEN Asymmetric large Baffle (Silver anodised)		DC 24V

ACCESSORIES

Mounting Accessories

KKCP-12	Lock Clip
KKBK-02	Fixed bracket
KKBK-09	Mounting plate
KKBK-16	Small adjustable bracket
KKBK-17	Large adjustable bracket
KKBK-23	Low adjustable bracket

* Refer to **Mounting accessories** on **Accessories** pages

Connection Accessories

CN67-2P-0300	IP67 2 PIN male & female 300mm/11.81" pair
CN67-2P-1000	IP67 2 PIN male & female 1000mm/39.37" pair
CN67-2P-3000	IP67 2 PIN male & female 3000mm/118.11" pair

* Refer to **Power feed** on **Accessories** pages

Exterior Junction Boxes

KKJB-07	IP67 Slim J-Box
KKJB-07R	Potting Resin for IP67 Slim J-Box

* Refer to **Exterior Junction Boxes** on **Accessories** pages

PSU/Driver

0-10V/1-10V/DALI/DMX

* Refer to **Driver/PSU Options** page for details or provide requirement and KKDC to offer the suitable option

SEN Asymmetric A040 (40W) Length Availability List



Length Code		Fixture Length ¹		LED Strip ²		End Cap Dimension ³		Wattage (W)	Output (lm)
Metric	Imperial(US)	Metric	Imperial(US)	Metric	Imperial(US)	Metric	Imperial(US)		3000K (Test Data)
m0097	i0004	97mm	3.82in	77mm	3.03in	10mm	0.39in	3.08	280
m0135	i0005	135mm	5.33in	115mm	4.54in	10mm	0.39in	4.62	420
m0174	i0007	174mm	6.84in	154mm	6.06in	10mm	0.39in	6.15	560
m0212	i0008	212mm	8.36in	192mm	7.57in	10mm	0.39in	7.69	700
m0251	i0010	251mm	9.87in	231mm	9.09in	10mm	0.39in	9.23	840
m0289	i0011	289mm	11.39in	269mm	10.60in	10mm	0.39in	10.77	980
m0328	i0013	328mm	12.90in	308mm	12.11in	10mm	0.39in	12.31	1120
m0366	i0014	366mm	14.42in	346mm	13.63in	10mm	0.39in	13.85	1260
m0405	i0016	405mm	15.93in	385mm	15.14in	10mm	0.39in	15.38	1400
m0443	i0017	443mm	17.44in	423mm	16.66in	10mm	0.39in	16.92	1540
m0482	i0019	482mm	18.96in	462mm	18.17in	10mm	0.39in	18.46	1680
m0520	i0020	520mm	20.47in	500mm	19.69in	10mm	0.39in	20.00	1820
m0558	i0022	558mm	21.99in	538mm	21.20in	10mm	0.39in	21.54	1960
m0597	i0024	597mm	23.50in	577mm	22.71in	10mm	0.39in	23.08	2100
m0635	i0025	635mm	25.02in	615mm	24.23in	10mm	0.39in	24.61	2240
m0674	i0027	674mm	26.53in	654mm	25.74in	10mm	0.39in	26.15	2380
m0712	i0028	712mm	28.04in	692mm	27.26in	10mm	0.39in	27.69	2520
m0751	i0030	751mm	29.56in	731mm	28.77in	10mm	0.39in	29.23	2660
m0789	i0031	789mm	31.07in	769mm	30.28in	10mm	0.39in	30.77	2800
m0828	i0033	828mm	32.59in	808mm	31.80in	10mm	0.39in	32.31	2940
m0866	i0034	866mm	34.10in	846mm	33.31in	10mm	0.39in	33.84	3079
m0905	i0036	905mm	35.61in	885mm	34.83in	10mm	0.39in	35.38	3220
m0943	i0037	943mm	37.13in	923mm	36.34in	10mm	0.39in	36.92	3360
m0982	i0039	982mm	38.64in	962mm	37.86in	10mm	0.39in	38.46	3500
m1020	i0040	1020mm	40.16in	1000mm	39.37in	10mm	0.39in	40.00	3640

¹ Actual total overall length of light fixture (LED strip + end caps + void/wire hole)

² Actual length of PCB strip

³ Actual length of 2x end caps

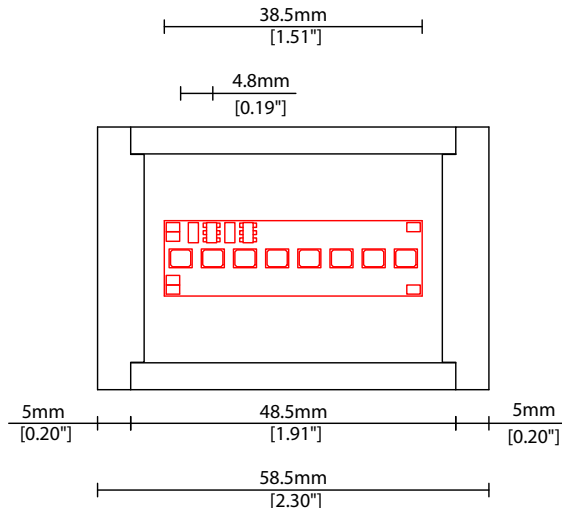

Linear

SEN Asymmetric A040 (40W) Options

KKDÖ

CABLE EXIT OPTIONS



RC Rear cable exit

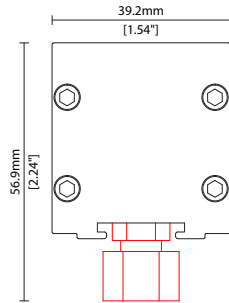

SC Side cable exit

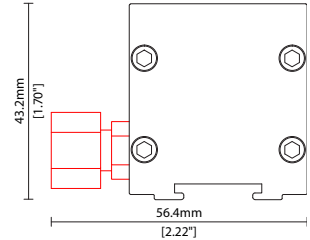

BAFFLE OPTIONS



SLB

SEN Asymmetric large
Baffle (Silver anodised)

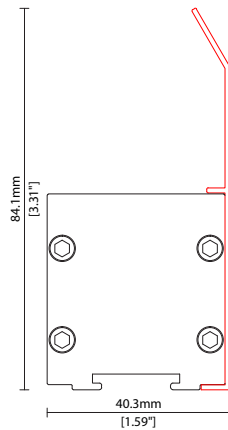

SSB

SEN Asymmetric small
Baffle (Silver anodised)

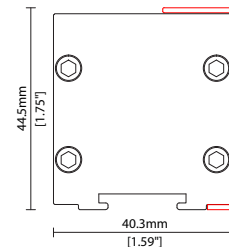

Key

Control Gear Power supply, sub-controllers & control systems
JB Junction box / cable connection

Linear

SEN Asymmetric A040 (40W) Options



POWER FEED OPTIONS

0300 S00B 300mm (11.81") Single Ø6.3mm sheath tail

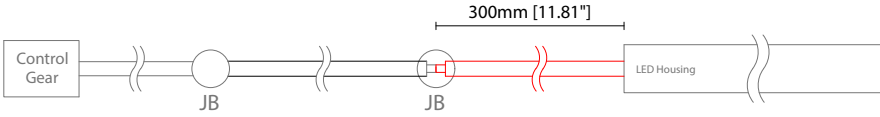

0300 D00B 300mm (11.81") Double Ø6.3mm sheath tail

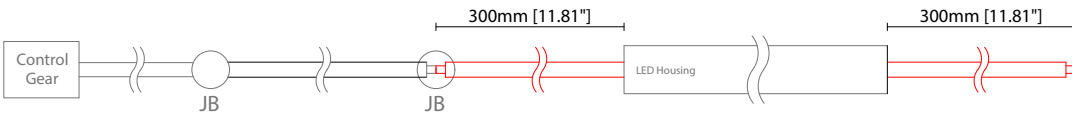

0300 S67B 300mm (11.81") Single Ø6.3mm sheath IP67 connector

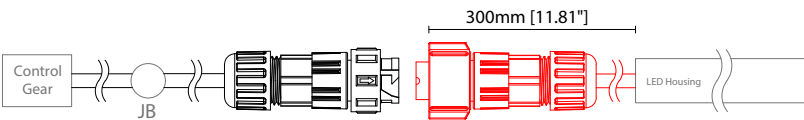

0300 D67B 300mm (11.81") Double Ø6.3mm sheath IP67 connector

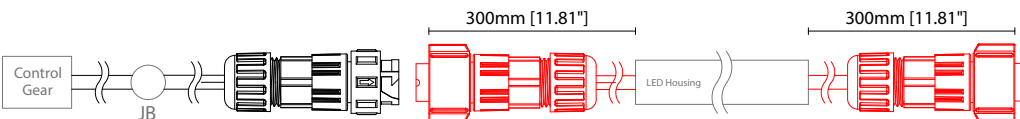

2 Pin Female Connector IP67

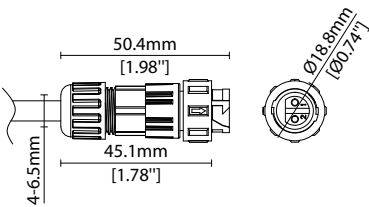

2 Pin Male Connector IP67

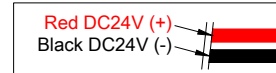
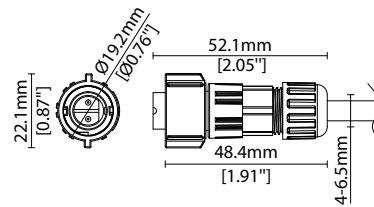

MOUNTING ACCESSORIES

Note: Accessories are to be ordered separately with corresponding code shown below.



KKCP-12

Lock clip (allow 2 per metre/40in)
S/Steel finish

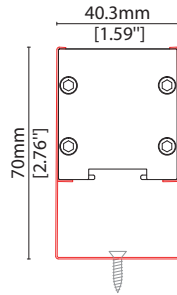

KKBK-02

Fixed bracket (allow 2 per metre/40in)
S/Steel finish

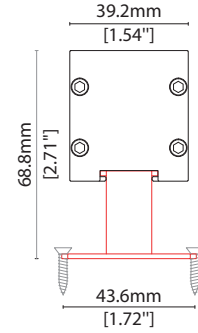

KKBK-09

Mounting plate
(allow 2 per metre/40in)
Silver anodised aluminium finish

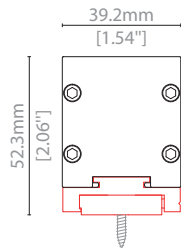

KKBK-23

Low adjustable bracket
(allow 2 per metre/40in)
Silver anodised aluminium finish

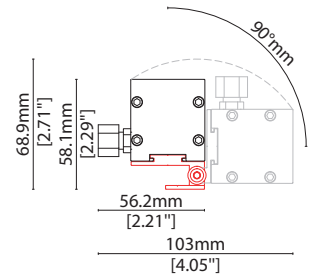

KKBK-16

Small adjustable bracket
(allow 2 per metre/40in)
Silver anodised aluminium finish

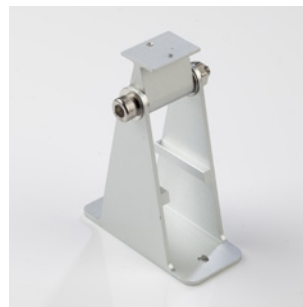
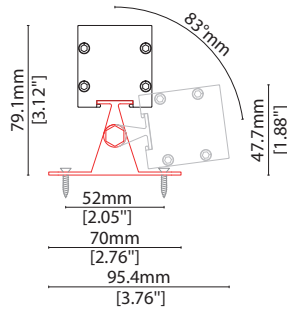

KKBK-17

Large adjustable bracket
(allow 2 per metre/40in)
Silver anodised aluminium finish

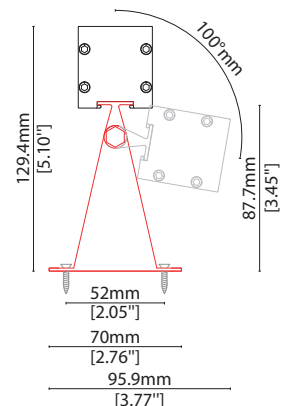

Linear

SEN Asymmetric A040 (40W) Accessories

KKDC

POWER FEED

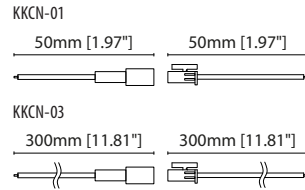
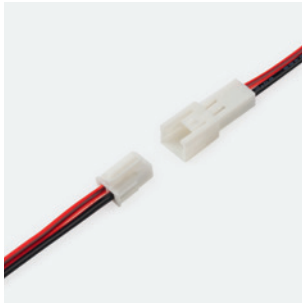

KKCN-01 50mm (1.97in) pair
KKCN-03 300mm (11.81in) pair
2 PIN male + female connector set

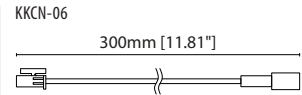

KKCN-06
2 PIN 300mm (11.81in) extension lead

EXTERIOR JUNCTION BOXES



KKJB-07
IP67 Slim J-Box
(including type A,B,C,D bushings)



KKJB-07R
Potting resin for IP67 Slim J-Box

SEN Asymmetric A040 (40W)

Driver/PSU Options



AVAILABLE PSU OPTIONS

Control Mode	PSU (Order Code)	Input Voltage AC	Output Voltage DC	Rated Output Current	Rated Power	Dim %	IP Rating
Switched	CEN-60-24	90-295V	24V	2.5A	60W	-	IP67
	HLG-60H-24	90-305V	24V	2.5A	60W	-	IP67
	HLG-100H-24	90-305V	24V	4.0A	100W	-	IP67
	HLG-150H-24	90-305V	24V	6.3A	150W	-	IP67
	HLG-240H-24	90-305V	24V	10A	240W	-	IP67
0-10V (1-10V)	PWM-40-24	90-305V	24V	1.67A	40W	100-0.15 (100-10)	IP67
	PWM-60-24	90-305V	24V	2.5A	60W	100-0.15 (100-10)	IP67
	PWM-90-24	90-305V	24V	3.67A	90W	100-0.15 (100-10)	IP67
	PWM-120-24	90-305V	24V	5.0A	120W	100-0.15 (100-10)	IP67
DALI	LIN100A1	120-277V	24V	1A per channel	100W	100-0.1	IP66/IP40
DMX RGB	LIN100A1	120-277V	24V	1.33A per channel	100W	100-0.1	IP66/IP40
DMX RGBW	LIN100A1	120-277A	24V	1A per channel	100W	100-0.1	IP66/IP40

Flicker Free Options - Combination of PSU+ sub-controller

Control Mode	PSU (Order Code)	Sub-controller (Order Code)	Input Voltage AC	Output Voltage DC	Rated Output Current	Rated Power	Dim %	IP Rating PSU/ Sub-controller
0-10V or 1-10V	CEN-60-24	KKDM-06	90-295V	24V	2.5A	60W	100-0.9	IP67/IP20
	HLG-60H-24	KKDM-06	90-295V	24V	2.5A	60W	100-0.9	IP67/IP20
	HLG-100H-24	KKDM-06	90-295V	24V	4.0A	100W	100-0.9	IP67/IP20
	HLG-150H-24	KKDM-06	90-295V	24V	6.3A	150W	100-0.9	IP67/IP20
	HLG-240H-24	KKDM-06	90-295V	24V	10.0A	240W	100-0.9	IP67/IP20
DALI	CEN-60-24	KKDL-02/03	90-295V	24V	2.5A	60W	100-0.1	IP67/IP20
	HLG-60H-24	KKDL-02/03	90-305V	24V	2.5A	60W	100-0.1	IP67/IP20
	HLG-100H-24	KKDL-02/03	90-305V	24V	4.0A	100W	100-0.1	IP67/IP20
	HLG-150H-24	KKDL-02/03	90-305V	24V	6.3A	150W	100-0.1	IP67/IP20
	HLG-240H-24	KKDL-02/03	90-305V	24V	10.0A	240W	100-0.1	IP67/IP20
DMX RGB	CEN-60-24	KKSC-05	90-295V	24V	2.5A	60W	100-0.9	IP67/IP20
	HLG-60H-24	KKSC-05	90-305V	24V	2.5A	60W	100-0.9	IP67/IP20
	HLG-100H-24	KKSC-05	90-305V	24V	4A	100W	100-0.9	IP67/IP20
	HLG-150H-24	KKSC-05	90-305V	24V	6.3A	150W	100-0.9	IP67/IP20
	HLG-240H-24	KKSC-05	90-305V	24V	10.0A	240W	100-0.9	IP67/IP20

¹ The items shown above cover the most frequently used specification but does not exhaust the possible options

² PSU and/or driver can be chosen from the table, or KKDC may recommend the best option upon receipt of the controls requirement and installation environment

³ Electrical shop drawing will include detailed information of PSU and relevant control drivers

⁴ Cut sheets are available on the controls section of www.kkdc.lighting or upon request